

Panasonic

Integrated Telephone System

Model No. **KX-TS15-W**

Pulse-or-tone dialing capability

Operating Instructions

Preparation

Basic Operation

Advanced Operation

Useful Information

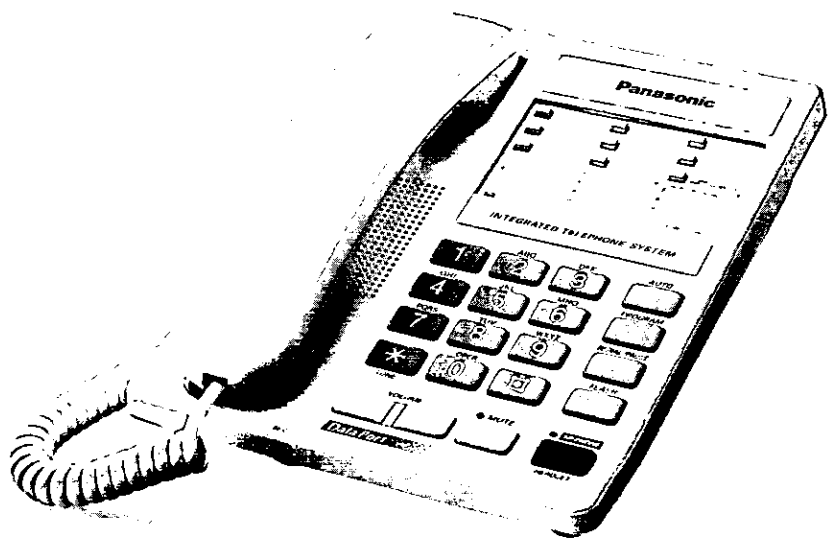

Data Port

PLEASE READ BEFORE USE AND SAVE.

Before Initial Use

Please read **IMPORTANT SAFETY INSTRUCTIONS** on pages 26–27 before use. Read and understand all instructions.

Thank you for purchasing your new Panasonic integrated telephone.

Attach your purchase receipt here.

For your future reference

Serial No. _____

Date of purchase _____

(found on the bottom of the unit)

Name and address of dealer _____

Accessories (Included) To order, call 1-800-332-5368.

- Handset (p. 5)
Order No. PQJXF0102Z

one

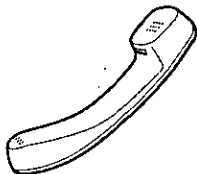

- Handset Cord (p. 5)
Order No. PQJA212M

one

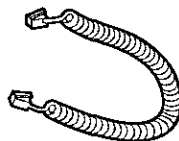

- Telephone Line Cord (p. 5)

one

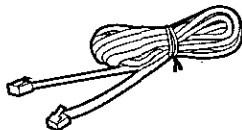

- Wall Mounting Adaptor (p. 21)
Order No. PQKL24Y81

one

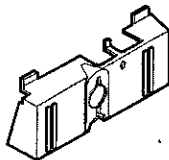

Contents

Preparation

Location of Controls	4
Settings	5
Connecting the Handset/Telephone Line Cord	5
Connecting a Communication Device	6
Selecting the Dialing Mode	7
Selecting the Ringer Volume	8
Selecting the Ringer Tone (5 Types).....	9
Turning the Ringer On/Off	9

Basic Operation

Making Calls	10
Answering Calls	12

Advanced Operation

Speed Dialer	13
Storing Phone Numbers in Memory	13
Dialing a Stored Number	15
One-Touch Dialer	16
Storing Phone Numbers in Memory	16
Dialing a Stored Number	18
Special Features	19
For Call Waiting Service Users	19
Temporary Tone Dialing (For Rotary or Pulse Service Users)	19
Muting Your Conversation	19
How to Use the PAUSE Button (For Analog PBX Line/Long Distance Service Users)	20

Useful Information

Wall Mounting	21
Using an Optional Headset	22
Connecting an Optional Headset to the Unit	22
Making/Answering Calls	23
Before Requesting Help	24
Important Safety Instructions	26
FCC and Other Information	28

Settings



Connecting the Handset/Telephone Line Cord

After connecting the handset and telephone line cord, lift the handset to confirm the dial tone.

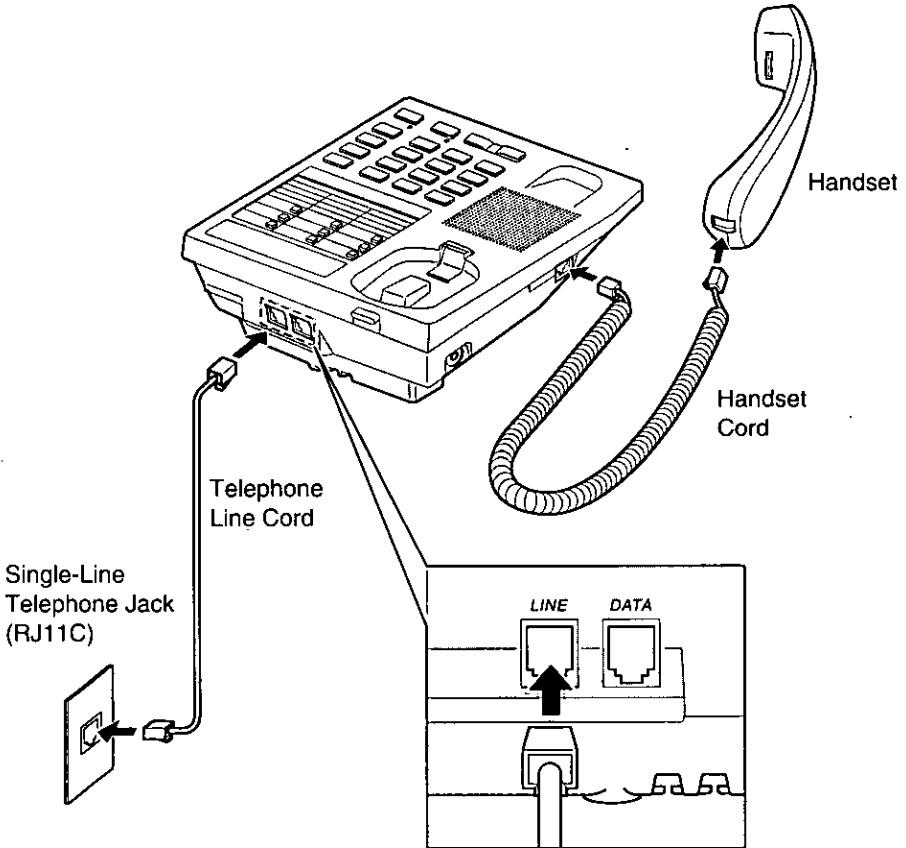

- Use only a Panasonic Handset for the KX-TS15-W.

Connecting a Communication Device

If you connect a communication device (computer, modem, fax, answering machine, etc.) to the telephone line, you can connect it through this unit using the DATA jack (—Data Port).

After connecting the handset and telephone line cord, connect the communication device telephone line cord to the DATA jack.

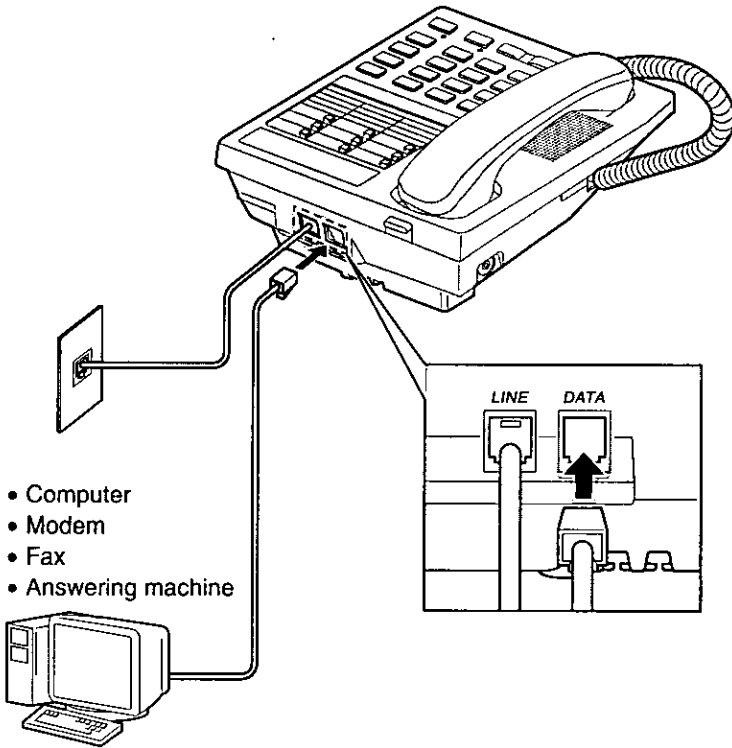

- Be sure that the communication device is not in use before using this unit (making calls, storing phone numbers in memory, etc.), or the communication device may not operate properly.



Selecting the Dialing Mode

You can select the dialing mode by programming. If you have touch tone service, set to TONE. If rotary or pulse service is used, set to PULSE. Your phone comes from the factory set to TONE.

- 1 Lift the handset.
- 2 Press **PROGRAM**.
 - The MUTE indicator flashes.
- 3 Press **3**.
- 4 To select PULSE, press **0**.
OR
To select TONE, press **1**.
- 5 Press **PROGRAM**.
 - A beep sounds on the handset and the MUTE indicator light goes out.
- 6 When finished, replace the handset.

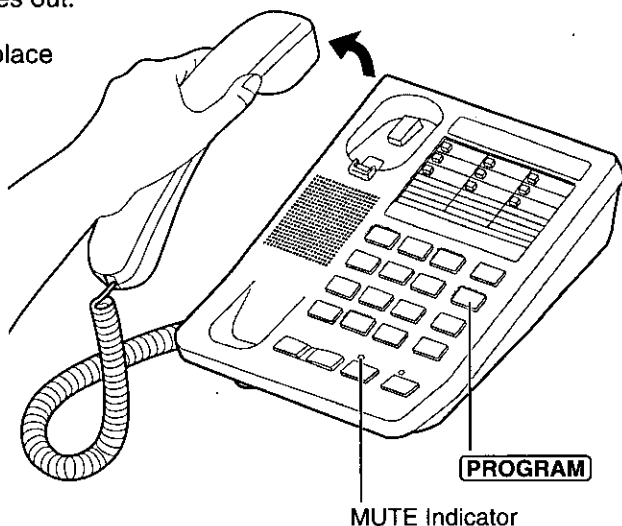

- To cancel during programming, replace the handset, then start from step 1.
- If 4 beeps sound during programming, a wrong key was pressed. Replace the handset, then start from step 1.

Selecting the Ringer Volume

You can select the ringer volume by programming. Set to HIGH, MID or LOW. Your phone comes from the factory set to HIGH.

- 1 Lift the handset.
- 2 Press **PROGRAM**.
 - The MUTE indicator flashes.
- 3 Press **6**.
- 4 To select LOW, press **1**.
To select MID, press **2**.
OR
To select HIGH, press **3**.
 - Each time you press a button, the selected volume will ring.
- 5 Press **PROGRAM**.
 - A beep sounds on the handset.
- 6 When finished, replace the handset.

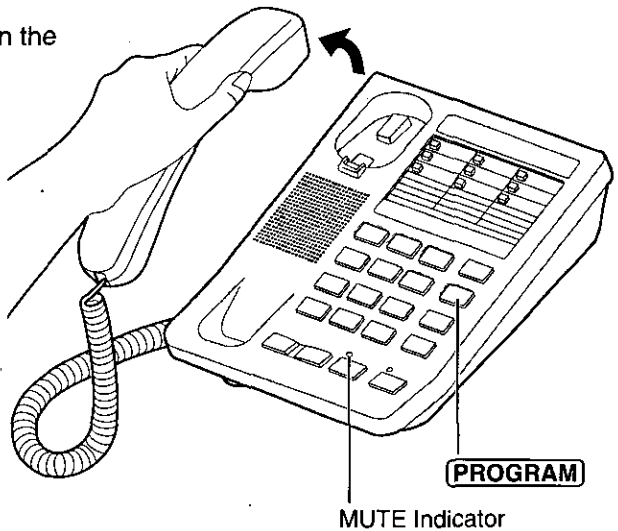

- To cancel during programming, replace the handset, then start from step 1.
- If 4 beeps sound during programming, a wrong key was pressed. Replace the handset, then start from step 1.
- If you change the ringer volume when the ringer is set to OFF (p. 9), the ringer will automatically turn ON.

Selecting the Ringer Tone (5 Types)

You can select one of 5 types of ringer tones. Your phone comes from the factory set to type 2.

1. Lift the handset.
 2. Press **PROGRAM**.
 - The MUTE indicator flashes.
 3. Press **7**.
 4. Press a dialing button **0** to **4**.
 - Each time you press a button, the selected tone will ring.
 5. Press **PROGRAM**.
 - A beep sounds on the handset.
 6. When finished, replace the handset.
- To cancel during programming, replace the handset, then start from step 1.
 - If 4 beeps sound during programming, a wrong key was pressed. Replace the handset, then start from step 1.
 - If you change the ringer tone when the ringer is set to OFF, the ringer will automatically turn ON.

Turning the Ringer On/Off

When set to OFF, the unit will not ring. Your phone comes from the factory set to ON.

1. Lift the handset.
 2. Press **PROGRAM**.
 - The MUTE indicator flashes.
 3. Press **9**.
 4. To turn OFF, press **0**.
OR
To turn ON, press **1**.
 5. Press **PROGRAM**.
 - A beep sounds on the handset and the MUTE indicator light goes out.
 6. When finished, replace the handset.
- To cancel during programming, replace the handset, then start from step 1.
 - If 4 beeps sound during programming, a wrong key was pressed. Replace the handset, then start from step 1.

Making Calls

You can make a call by simply lifting the handset. To hang up, place the handset on the cradle.

Using the speakerphone

1 Press **SP-PHONE/HEADSET**.

- The indicator lights.

2 Dial a phone number.

- If you misdial, hang up and start from step 1.

3 When the other party answers, talk into the **MIC** (microphone).

4 To hang up, press **SP-PHONE/HEADSET**.

- The indicator light goes out.

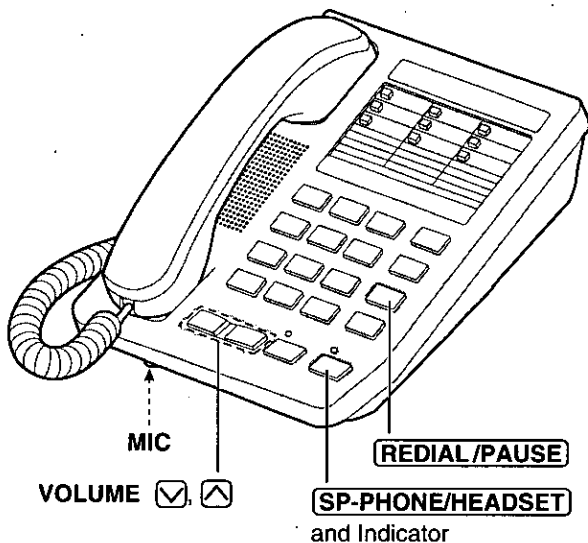

During the speakerphone operation:

- For best speakerphone performance, talk alternately with the caller in a quiet room.
- If the caller complains that your voice is hard to hear, press **VOLUME** to decrease the speaker volume.
- You can switch to the handset by lifting it up. To switch back to the speakerphone, press **SP-PHONE/HEADSET**.

To adjust the handset volume (5 levels) or the speaker volume (9 levels) while talking

To increase, press **VOLUME** . To decrease, press **VOLUME** .

- After hanging up, the handset volume will return to the middle level.

To redial the last number dialed

Lift the handset or press **SP-PHONE/HEADSET** ➔ press **REDIAL/PAUSE**.

Answering Calls

While a call is being received, the unit rings. You can answer it by simply lifting the handset.

Using the speakerphone

- 1 Press **SP-PHONE/HEADSET**.
 - The indicator lights.
- 2 Talk into the **MIC** (microphone).
- 3 To hang up, press **SP-PHONE/HEADSET**.
 - The indicator light goes out.

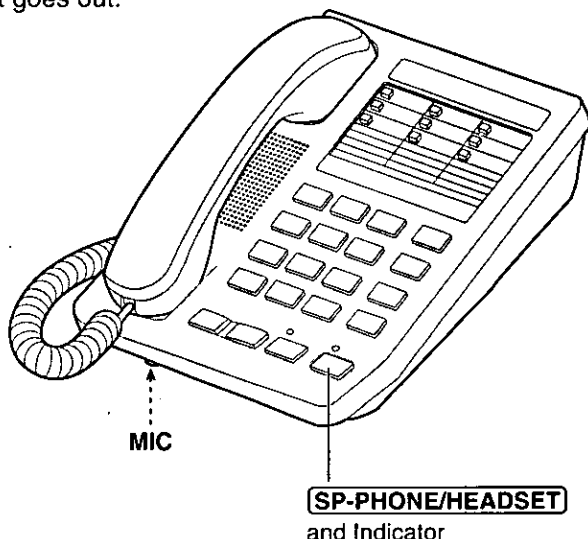

- When the ringer volume is set to OFF (p. 9), the unit will not ring.

When the optional headset is connected to the unit (p. 22), be sure to use the headset to talk with the caller. If you want to have a normal phone conversation, disconnect the headset before making or answering a call.



Storing Phone Numbers in Memory

You can store up to 10 phone numbers in the memory stations. The dialing buttons (0 to 9) function as memory station numbers. Do not press any memory stations before storing to prevent misoperation.

- 1 Lift the handset.
- 2 Press **PROGRAM**.
 - The MUTE indicator flashes.
- 3 Press **AUTO**.
- 4 Press a memory station number (0 to 9).
- 5 Enter a phone number up to 21 digits.
- 6 Press **PROGRAM**.
 - A beep sounds on the handset and the MUTE indicator light goes out.
- 7 When finished, replace the handset.
 - To store other numbers, repeat steps 1 through 7.

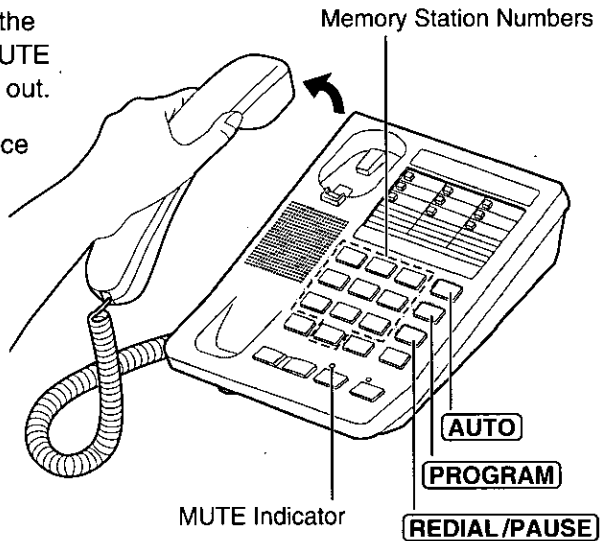

- If a pause is required for dialing, **REDIAL/PAUSE** can be stored in a phone number counting as one digit (p. 20).
- To cancel during programming, replace the handset, then start from step 1.
- If 4 beeps sound during programming, a wrong key was pressed. Replace the handset, then start from step 1.

➔ Speed Dialer

To erase a stored number

1. Lift the handset.
2. Press **PROGRAM**.
3. Press **AUTO**.
4. Press the memory station number (**0** to **9**) for the phone number to be erased.
5. Press **PROGRAM**, then replace the handset.

Memory card

Remove the memory card and use it as a name or phone number index for the stored numbers.

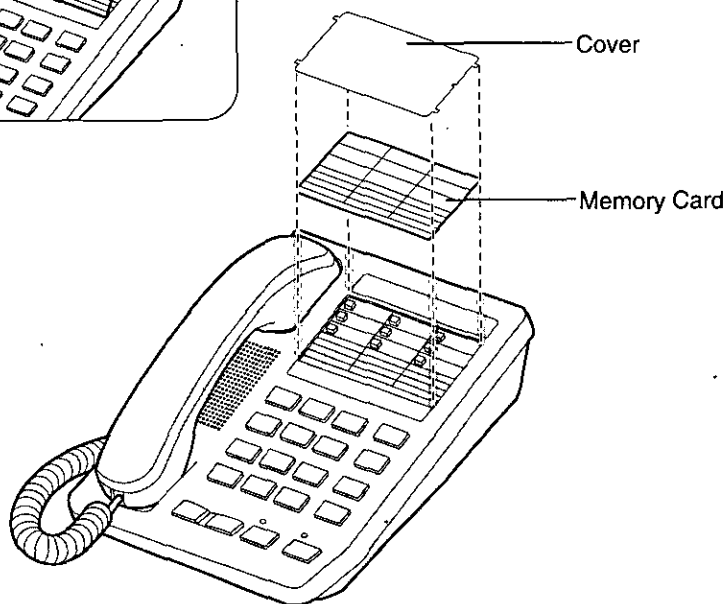
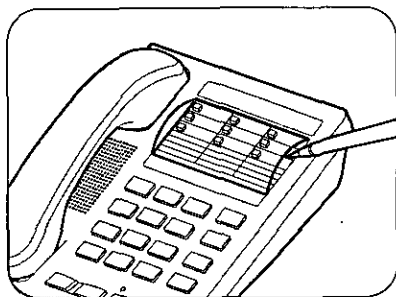

Dialing a Stored Number

- 1 Lift the handset or press **SP-PHONE/HEADSET**.
- 2 Press **AUTO**.
- 3 Press the memory station number (**0** to **9**).
 - The stored number is dialed.

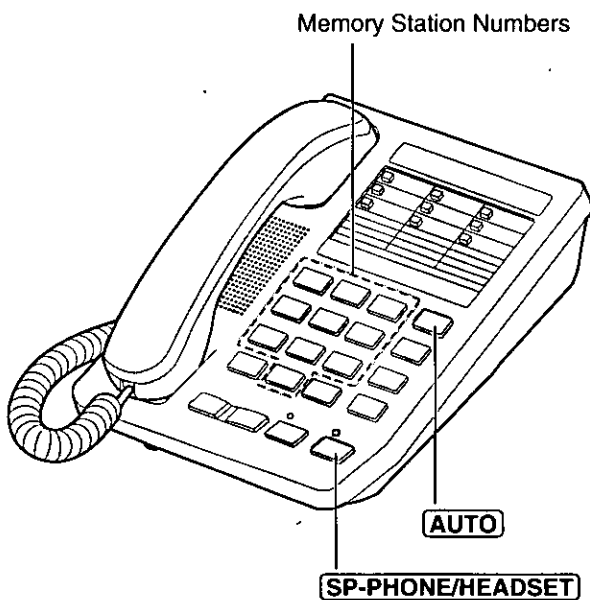

One-Touch Dialer

You can store up to 16 phone numbers in the one-touch auto dial buttons (8 numbers in UPPER memory locations, 8 numbers in LOWER memory locations).

Storing Phone Numbers in Memory

Do not press any one-touch auto dial buttons before storing to prevent misoperation.

To store in an UPPER memory location

- 1 Lift the handset.
- 2 Press **PROGRAM**.
 - The MUTE indicator flashes.
- 3 Press one of the one-touch auto dial buttons.
- 4 Enter a phone number up to 21 digits.
- 5 Press **PROGRAM**.
 - A beep sounds on the handset and the MUTE indicator light goes out.
- 6 When finished, replace the handset.
 - To store other numbers, repeat steps 1 through 6.

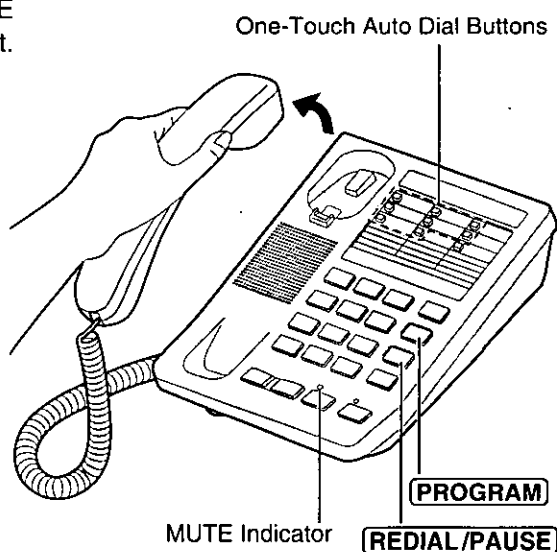



To store in a LOWER memory location

- 1 Lift the handset.
- 2 Press **PROGRAM**.
 - The MUTE indicator flashes.
- 3 Press **LOWER** to select a lower memory location.
- 4 Press one of the one-touch auto dial buttons.
- 5 Enter a phone number up to 21 digits.
- 6 Press **PROGRAM**.
 - A beep sounds on the handset and the MUTE indicator light goes out.
- 7 When finished, replace the handset.
 - To store other numbers, repeat steps 1 through 7.

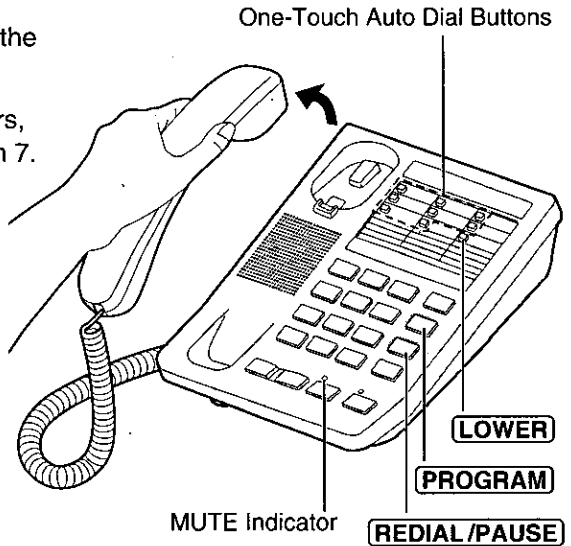

- If a pause is required for dialing, **REDIAL/PAUSE** can be stored in a phone number counting as one digit (p. 20).
- To cancel during programming, replace the handset, then start from step 1.
- If 4 beeps sound during programming, a wrong key was pressed. Replace the handset, then start from step 1.

➔ One-Touch Dialer

To erase a stored number

1. Lift the handset.
2. Press **PROGRAM**.
3. If the phone number is in an UPPER memory location, press the one-touch auto dial button for the phone number to be erased.
OR
If the phone number is in a LOWER memory location, press **LOWER**, then press the one-touch auto dial button for the phone number to be erased.
4. Press **PROGRAM**, then replace the handset.

Memory card

Use the memory card as a name or phone number index for the stored numbers (p. 14).

Dialing a Stored Number

With an UPPER memory location:

- 1 Lift the handset or press **SP-PHONE/HEADSET**.
- 2 Press the desired one-touch auto dial button.
 - The stored number is dialed.

OR

With a LOWER memory location:

- 1 Lift the handset or press **SP-PHONE/HEADSET**.
- 2 Press **LOWER**.
- 3 Press the desired one-touch auto dial button.
 - The stored number is dialed.

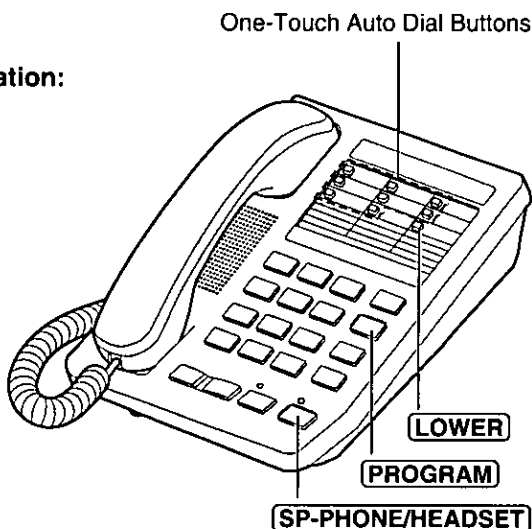

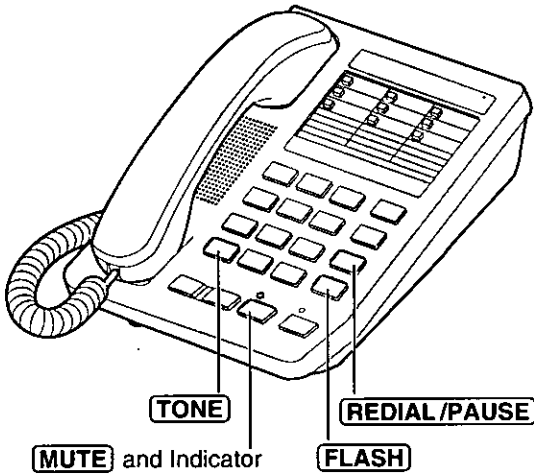

For Call Waiting Service Users

Press **FLASH** if you hear a call-waiting tone while talking.

- The first call is put on hold and you can answer the second call.
- To return to the first caller, press **FLASH** again.

Temporary Tone Dialing (For Rotary or Pulse Service Users)

Press **TONE** before entering access numbers which require tone dialing.

- The dialing mode changes to tone. You can enter numbers to access an answering service, electronic banking service, etc. When you hang up, the mode will return to pulse.

Muting Your Conversation

Press **MUTE** while talking. The indicator lights.

- The other party cannot hear your voice but you can hear theirs.
- To resume the conversation, press **MUTE** again.

➡ Special Features

How to Use the PAUSE Button (For Analog PBX Line/Long Distance Service Users)

We recommend you press **REDIAL/PAUSE** if a pause is required for dialing with a PBX or to access a long distance service.

Ex. Line access number **9** (PBX)

9 ➡ **REDIAL/PAUSE** ➡ Phone number

- Pressing **REDIAL/PAUSE** once creates a 3.5 second pause. This prevents misdialing when you redial or dial a stored number.
- Pressing **REDIAL/PAUSE** more than once increases the length of the pause between numbers.
- When you store phone numbers in memory or press **REDIAL/PAUSE** to redial, if **REDIAL/PAUSE** is stored anywhere after the first 5 digits, dialing will stop where **REDIAL/PAUSE** was entered. Press **REDIAL/PAUSE** to continue dialing.

Ex. To access a voice mail service: "1234567 **REDIAL/PAUSE** 890" is stored in an UPPER memory location in a one-touch auto dial button (for the One-Touch Dialer). "890" is the access number. Lift the handset or press **SP-PHONE/HEADSET** ➡ press the one-touch auto dial button ("1234567" is dialed) ➡ follow the pre-recorded instructions ➡ press **REDIAL/PAUSE** ("890" is dialed).

Wall Mounting

This unit can be mounted on a wall phone plate.

- 1 Pull down the handset hook until it locks, so the tab holds the handset.

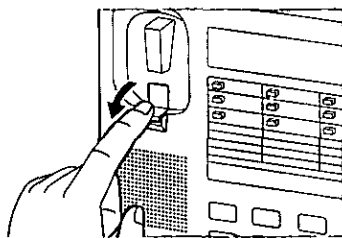

- 2 Tuck the telephone line cord inside the wall mounting adaptor, then push it in the direction of the arrow.

- The word "UP" should face upward.

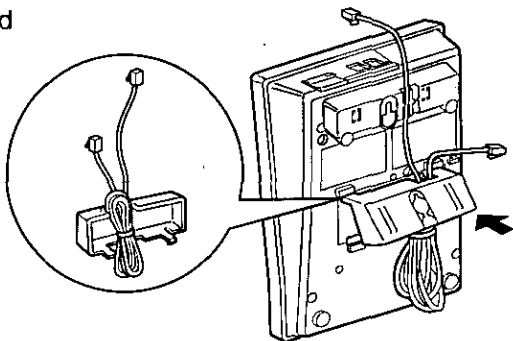

- 3 Connect the telephone line cord. Mount the unit, then slide down.

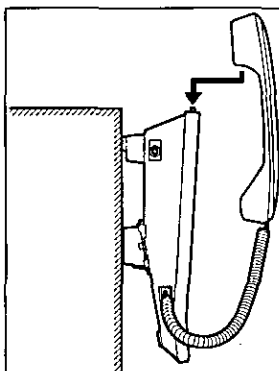
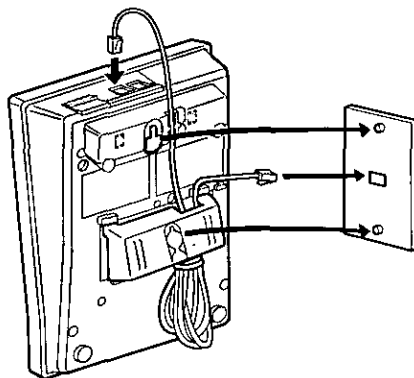

To temporarily set the handset down during a conversation, place it as shown here.

Using an Optional Headset

Plugging an optional headset into the unit provides a hands-free phone conversation.

Please use only a Panasonic KX-TCA80 or KX-TCA90 headset. To order, call the accessories telephone number on page 2.

When the optional headset is connected to the unit, be sure to use the headset to talk with the caller. If you want to have a normal phone conversation, disconnect the headset before making or answering a call.

Connecting an Optional Headset to the Unit

Connect an optional headset to the headset jack as shown below.

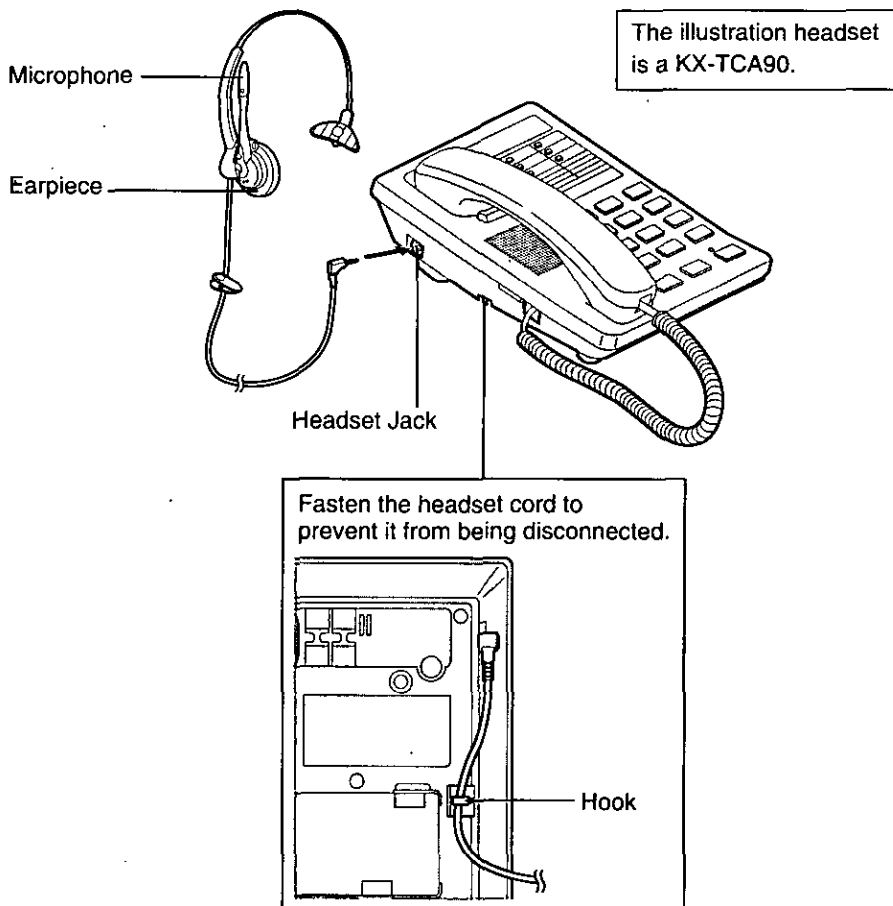

Making/Answering Calls

- 1 Press **SP-PHONE/HEADSET** to make or answer a call.
 - The SP-PHONE/HEADSET indicator lights.
 - If you misdial when making a call, press **SP-PHONE/HEADSET** twice and dial again.
- 2 To hang up, press **SP-PHONE/HEADSET**.
 - The indicator light goes out.

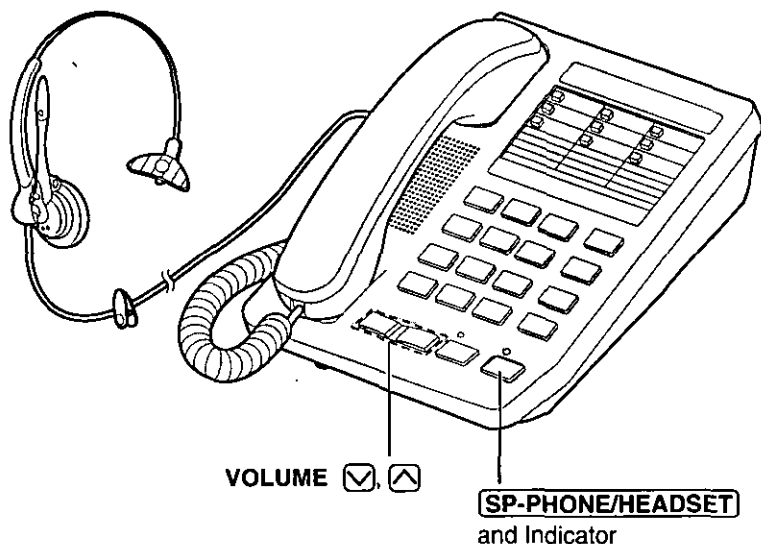

To adjust the headset receiver volume (5 levels):

While using the headset, press **VOLUME** or .

- After hanging up, the volume will return to the middle level.
- During a conversation with the optional headset, you cannot switch the call to the handset by lifting it off the cradle.
- If you disconnect the optional headset during a conversation, you can continue the conversation with the handset by lifting it up. But the call cannot be switched to the speakerphone.
- During a conversation with the speakerphone, you cannot switch the call to the optional headset by connecting the headset.

Before Requesting Help

Problem	Remedy
The unit does not work.	<ul style="list-style-type: none">• Check the settings (p. 5–9).
The call cannot be connected even you dialed correctly.	<ul style="list-style-type: none">• Check whether the dialing mode selection is correct or not (p. 7).
The unit does not ring.	<ul style="list-style-type: none">• The ringer is set to OFF. Set to ON (p. 9).
The other party suddenly cannot hear your voice during a conversation.	<ul style="list-style-type: none">• MUTE may have been pressed during the conversation. If the MUTE indicator lights, press MUTE.
You cannot store a phone number in memory.	<ul style="list-style-type: none">• Confirm the handset is off the cradle.• Do not enter a phone number more than 21 digits long, or the entered number will be erased.
REDIAL/PAUSE does not function properly.	<ul style="list-style-type: none">• The button has a double function as either redial or pause. It will redial the last number dialed if pressed at the outset of a call (p. 11). If another number has been dialed first, it will operate as a pause button (p. 20).
You cannot have a conversation using the optional headset.	<ul style="list-style-type: none">• Make sure that the optional headset is connected properly (p. 22).• Press SP-PHONE/HEADSET to make or answer a call.• If you lift the handset and replace it back on the cradle, the call will be disconnected.

Problem	Remedy
You cannot have a conversation using the handset or speakerphone.	<ul style="list-style-type: none">• When the optional headset is plugged into the unit (p. 22), you must use the headset to talk with the caller. To have a normal phone conversation, disconnect the optional headset before making or answering a call.
If you cannot solve your problem	<ul style="list-style-type: none">• Call our customer call center at 1-800-211-PANA(7262).

Important Safety Instructions

When using this unit, basic safety precautions should always be followed to reduce the risk of fire, electric shock, or personal injury.

1. Read and understand all instructions.
2. Follow all warnings and instructions marked on this unit.
3. Unplug this unit from wall outlets before cleaning. Do not use liquid or aerosol cleaners. Use a damp cloth for cleaning.
4. Do not use this unit near water, for example, near a bathtub, washbowl, kitchen sink, or the like.
5. Place this unit securely on a stable surface. Serious damage and/or injury may result if the unit falls.
6. Do not cover slots and openings on the unit. They are provided for ventilation and protection against overheating. Never place the unit near radiators, or in a place where proper ventilation is not provided.
7. Do not place objects on the power cord. Install the unit where no one can step or trip on the cord.
8. Do not overload wall outlets and extension cords. This can result in the risk of fire or electric shock.
9. Never push any objects through slots in this unit. This may result in the risk of fire or electric shock. Never spill any liquid on the unit.
10. To reduce the risk of electric shock, do not disassemble this unit. Take the unit to an authorized servicer when service is required. Opening or removing covers may expose you to dangerous voltages or other risks. Incorrect reassembly can cause electric shock when the unit is subsequently used.
11. Unplug this unit from the wall outlet and refer servicing to an authorized servicer when the following conditions occur:
 - A. When the power supply cord or plug is damaged or frayed.
 - B. If liquid has been spilled into the unit.
 - C. If the unit has been exposed to rain or water.
 - D. If the unit does not work normally by following the operating instructions. Adjust only controls covered by the operating instructions. Improper adjustment may require extensive work by an authorized servicer.
 - E. If the unit has been dropped or physically damaged.
 - F. If the unit exhibits a distinct change in performance.

-
12. During thunderstorms, avoid using telephones except cordless types.
There may be a remote risk of an electric shock from lightning.
 13. Do not use this unit to report a gas leak, when in the vicinity of the leak.

SAVE THESE INSTRUCTIONS

WARNING:

TO PREVENT FIRE OR SHOCK HAZARD, DO NOT EXPOSE THIS PRODUCT TO RAIN OR ANY TYPE OF MOISTURE.

FCC and Other Information

If requested by the telephone company, inform them as follows:

FCC Registration No.(found on the bottom of the unit)

Ringer Equivalence1.0B

The particular telephone line to which the equipment is connected.

This unit must not be connected to a coin operated line.

If you are on a party line, check with your local telephone company.

Ringer Equivalence No. (REN):

The REN is useful in determining the quantity of devices you may connect to your telephone line and still have all of those devices ring when your telephone number is called. In most, but not all areas, the sum of the REN's of all devices connected to one line should not exceed five (5.0). To be certain of the number of devices you may connect to your line, as determined by the REN, you should contact your local telephone company to determine the maximum REN for your calling area.

In the event terminal equipment causes harm to the telephone network, the telephone company should notify the customer, if possible, that service may be stopped.

However, where prior notice is impractical, the company may temporarily cease service providing that they:

- (a) Promptly notify the customer.
- (b) Give the customer an opportunity to correct the problem with their equipment.
- (c) Inform the customer of the right to bring a complaint to the Federal Communication Commission pursuant to procedures set out in FCC Rules and Regulations Subpart E of Part 68.

The Telephone Company may make changes in its communications facilities, equipment, operations or procedures, where such action is reasonably required in the operation of its business and is not inconsistent with the rules and regulations in FCC Part 68.

If such changes can be reasonably expected to render any customer terminal equipment incompatible with telephone company communications facilities, or require modification or alteration of such terminal equipment, or otherwise materially affect its use or performance, the customer shall be given adequate notice in writing, to allow the customer an opportunity to maintain uninterrupted service.

When programming emergency numbers and/or making test calls to emergency numbers:

1. Remain on the line and briefly explain to the dispatcher the reason for the call before hanging up.
2. Perform such activities in the off-peak hours, such as early morning hours or late evenings.

This device complies with Part 15 of the FCC Rules. Operation is subject to the following two conditions: (1) This device may not cause harmful interference, and (2) this device must accept any interference received, including interference that may cause undesired operation.

CAUTION:

Any changes or modifications not expressly approved by the party responsible for compliance could void the user's authority to operate this device.

Note:

This equipment has been tested and found to comply with the limits for a Class B digital device, pursuant to Part 15 of the FCC Rules. These limits are designed to provide reasonable protection against harmful interference in a residential installation. This equipment generates, uses, and can radiate radio frequency energy and, if not installed and used in accordance with the instructions, may cause harmful interference to radio communications. However, there is no guarantee that interference will not occur in a particular installation. If this equipment does cause harmful interference to radio or television reception, which can be determined by turning the equipment off and on, the user is encouraged to try to correct the interference by one or more of the following measures:

- Reorient or relocate the receiving antenna.
 - Increase the separation between the equipment and receiver.
 - Connect the equipment into an outlet on a circuit different from that to which the receiver is connected.
 - Consult the dealer or an experienced radio/TV technician for help.
- **Environment** — do not place the unit in a room where the temperature is less than 5°C (41°F) or greater than 40°C (104°F). Allow 10 cm (4") clearance around the unit for proper ventilation. Avoid excessive smoke, dust, mechanical vibration, shock, or direct sunlight.
 - **Routine care** — wipe the unit with a soft cloth. Do not use benzine, thinner, or any abrasive powder.
 - **If there is any trouble** — disconnect the unit from the telephone line and connect a known working phone. If the known working phone operates properly, have your unit repaired by one of the authorized Panasonic Factory Service Centers. If the known working phone does not operate properly, consult with your telephone company.

For product service

- Panasonic Servicenters are listed in the servicenter directory.
- Call 1-800-211-PANA(7262) for the location of an authorized servicenter.

When you ship the product

- Carefully pack your unit, preferably in the original carton.
- Attach a letter, detailing the symptom, to the outside of the carton.

Symptom

- Send the unit to an authorized servicenter, prepaid and adequately insured.
- Do not send your unit to the Panasonic Consumer Electronics Company listed on the back cover or to executive or regional sales offices. These locations do not repair consumer products.

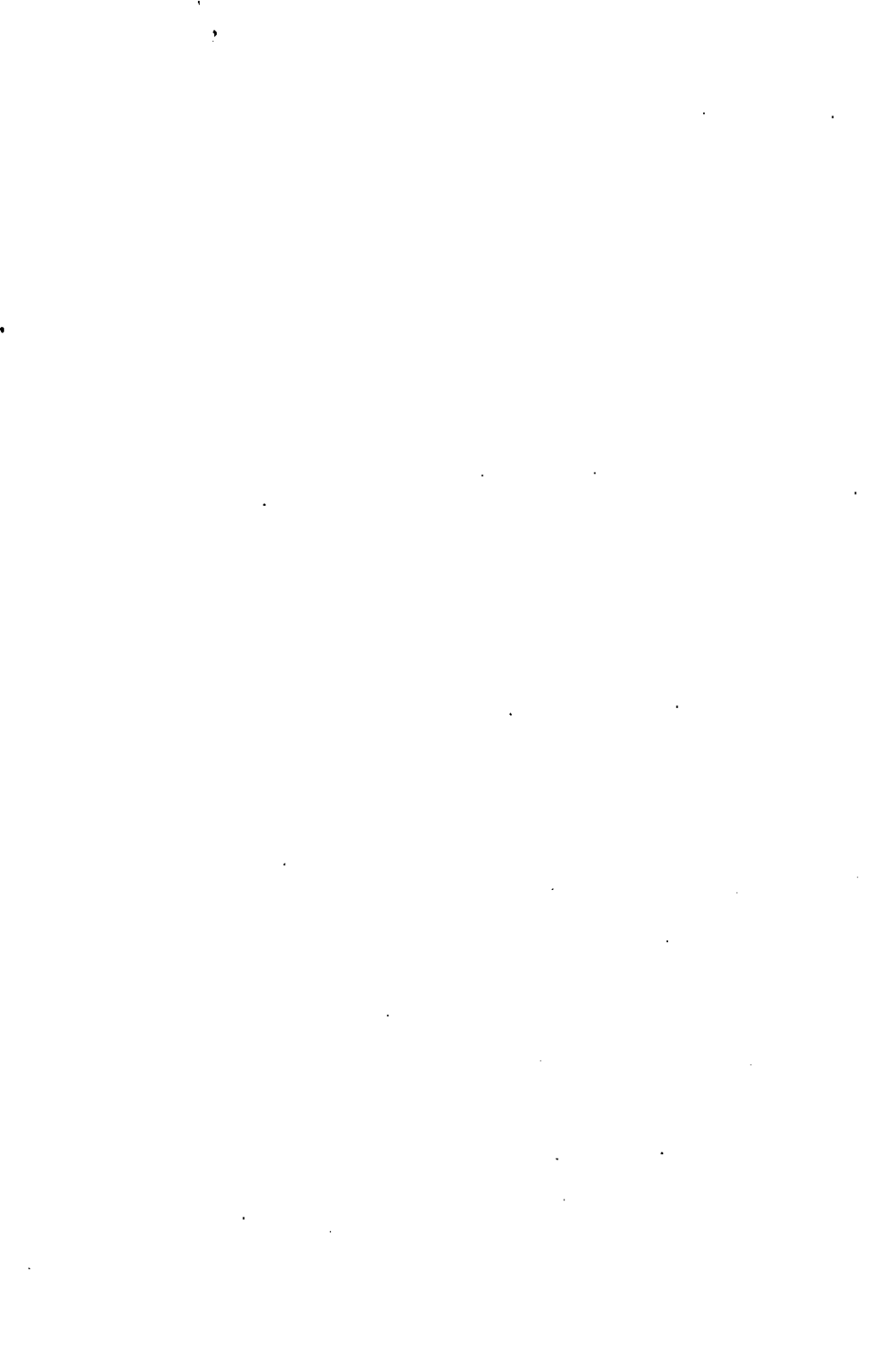

Panasonic Consumer Electronics Company,
Division of Matsushita Electric Corporation of America
One Panasonic Way, Secaucus, New Jersey 07094

Panasonic Sales Company,
Division of Matsushita Electric of Puerto Rico, Inc.
Ave. 65 de Infantería, Km. 9.5, San Gabriel Industrial Park
Carolina, Puerto Rico 00985